

$I_{F(AV)} = 3.5\text{Amp}$
 $V_R = 40\text{V}$

Major Ratings and Characteristics

Characteristics	Values	Units
$I_{F(AV)}$ Rectangular waveform	3.5	A
V_{RRM}	40	V
I_{FSM} @tp = 5 μ s sine	500	A
V_F @3 Apk, $T_J = 125^\circ\text{C}$	0.49	V
T_J	-40 to 150	$^\circ\text{C}$

Description/ Features

The 30WQ04FNPbF surface mount Schottky rectifier has been designed for applications requiring low forward drop and small foot prints on PC board. Typical applications are in disk drives, switching power supplies, converters, free-wheeling diodes, battery charging, and reverse battery protection.

- Popular D-PAK outline
- Small foot print, surface mountable
- Low forward voltage drop
- High frequency operation
- Guard ring for enhanced ruggedness and long term reliability
- Lead-Free ("PbF" suffix)

Case Styles



D-PAK (TO-252AA)

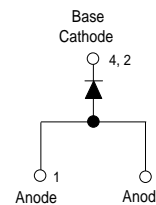

Voltage Ratings

Part number	30WQ04FNPbF
V_R Max. DC Reverse Voltage (V)	40
V_{RWM} Max. Working Peak Reverse Voltage (V)	

Absolute Maximum Ratings

Parameters	30WQ...	Units	Conditions
$I_{F(AV)}$ Max. Average Forward Current * See Fig. 5	3.5	A	50% duty cycle @ $T_C = 135^\circ\text{C}$, rectangular wave form
I_{FSM} Max. Peak One Cycle Non-Repetitive Surge Current * See Fig. 7	500	A	Following any rated load condition and with rated V_{RRM} applied
	80		
E_{AS} Non-Repetitive Avalanche Energy	8.0	mJ	$T_J = 25^\circ\text{C}$, $I_{AS} = 1\text{ Amp}$, $L = 16\text{ mH}$
I_{AR} Repetitive Avalanche Current	1.0	A	Current decaying linearly to zero in 1 μsec Frequency limited by T_J max. $V_A = 1.5 \times V_R$ typical

Electrical Specifications

Parameters	30WQ...	Units	Conditions
V_{FM} Max. Forward Voltage Drop * See Fig. 1 (1)	0.53	V	@ 3A
	0.67	V	@ 6A
	0.49	V	@ 3A
	0.62	V	@ 6A
I_{RM} Max. Reverse Leakage Current * See Fig. 2 (1)	2	mA	$T_J = 25^\circ\text{C}$
	24	mA	$T_J = 125^\circ\text{C}$
$V_{F(TO)}$ Threshold Voltage	0.34	V	$T_J = T_J$ max.
r_t Forward Slope Resistance	37.33	$\text{m}\Omega$	
C_T Typical Junction Capacitance	189	pF	$V_R = 5V_{DC}$ (test signal range 100Khz to 1Mhz) 25°C
L_S Typical Series Inductance	5.0	nH	Measured lead to lead 5mm from package body
dv/dt Max. Voltage Rate of Change	10000	V/ μs	(Rated V_R)

(1) Pulse Width < 300 μs , Duty Cycle < 2%

Thermal-Mechanical Specifications

Parameters	30WQ...	Units	Conditions
T_J Max. Junction Temperature Range (*)	-40 to 150	$^\circ\text{C}$	
T_{stg} Max. Storage Temperature Range	-40 to 150	$^\circ\text{C}$	
R_{thJC} Max. Thermal Resistance Junction to Case	4.7	$^\circ\text{C}/\text{W}$	DC operation * See Fig. 4
wt Approximate Weight	0.3 (0.01)	g (oz.)	
Case Style	D - PAK		Similar to TO-252AA
Marking Device	30WQ04FN		

(*) $\frac{dP_{tot}}{dT_J} < \frac{1}{R_{th(j-a)}}$ thermal runaway condition for a diode on its own heatsink

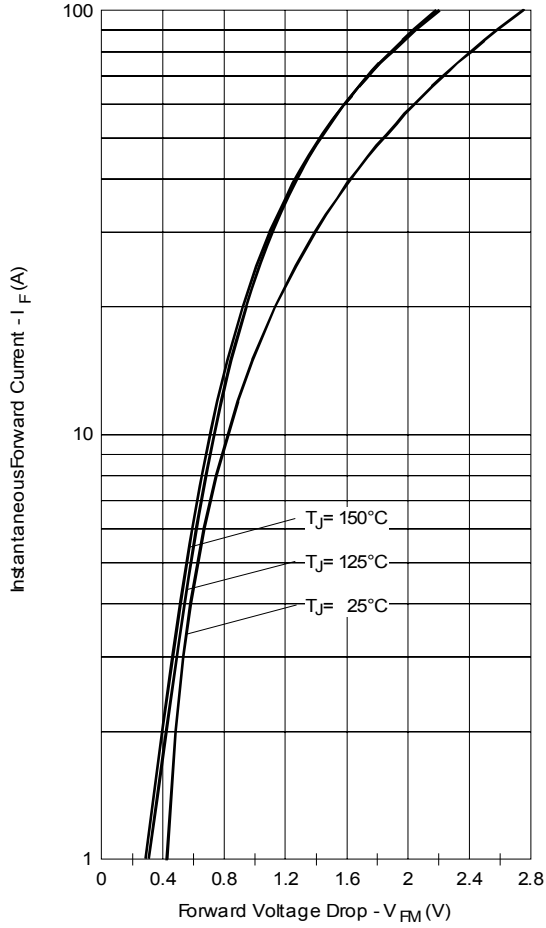

Fig. 1 - Maximum Forward Voltage Drop Characteristics

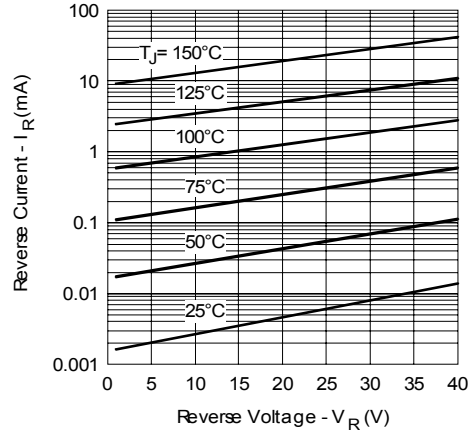

Fig. 2 - Typical Values of Reverse Current Vs. Reverse Voltage

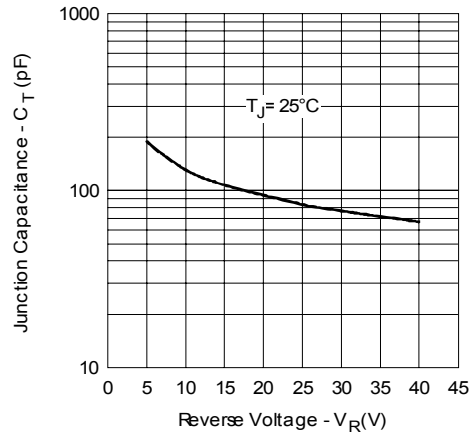

Fig. 3 - Typical Junction Capacitance Vs. Reverse Voltage

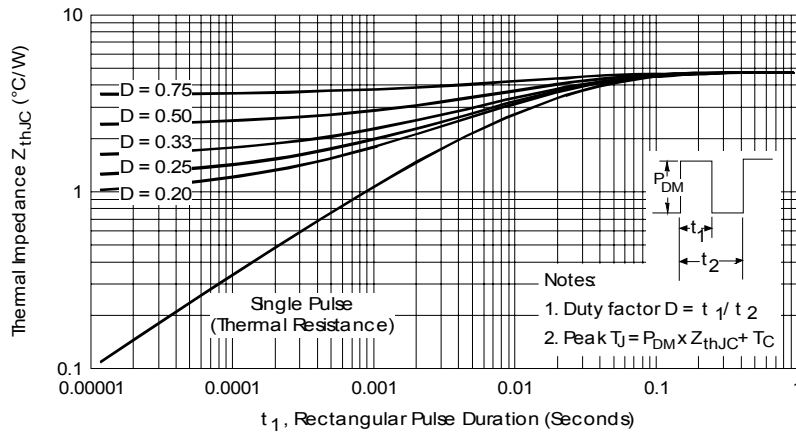

Fig. 4 - Maximum Thermal Impedance Z_{thJC} Characteristics

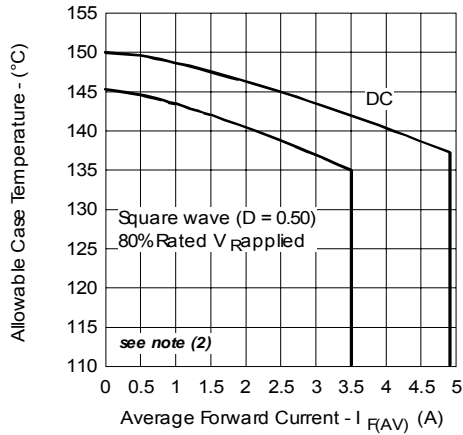

Fig. 5 - Maximum Allowable Case Temperature Vs. Average Forward Current

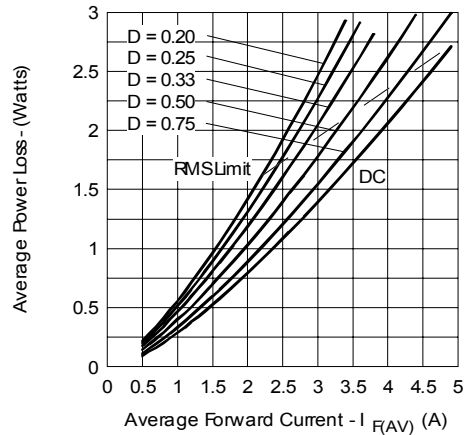

Fig. 6 - Forward Power Loss Characteristics

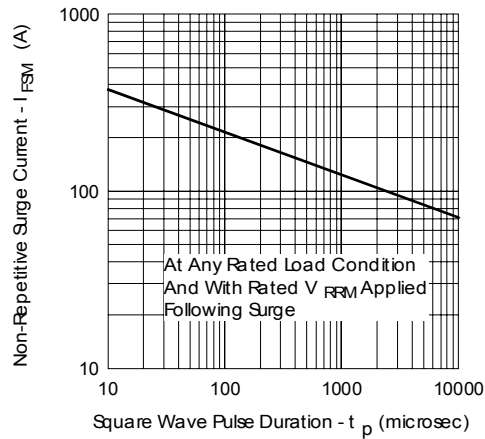

Fig. 7 - Maximum Non-Repetitive Surge Current

(2) Formula used: $T_c = T_j - (P_d + P_{d_{REV}}) \times R_{thJC}$;

P_d = Forward Power Loss = $I_{F(AV)} \times V_{FM} @ (I_{F(AV)} / D)$ (see Fig. 6);

$P_{d_{REV}}$ = Inverse Power Loss = $V_{R1} \times I_R (1 - D)$; $I_R @ V_{R1} = 80\%$ rated V_R

Outline Table

NOTES

- 1- DIMENSIONS AND TOLERANCES PER ASME Y14.3M-1994
- 2- DIMENSION ARE SHOWN IN INCHES (MILLIMETERS)
- 3- LEAD DIMENSION UNCONTROLLED IN 1.0
- 4- DIMENSION D1, E1, L3 & R3 ESTABLISH A MINIMUM MOUNTING SURFACE FOR THERMAL PAD.
- 5- SECTION C-C DIMENSIONS APPLY TO THE FLAT SECTION OF THE LEAD BETWEEN .005 AND 0.10 [0.13 AND 0.25] FROM THE LEAD TIP.
- 6- DIMENSION D & E DO NOT INCLUDE MOLD FLASH. MOLD FLASH SHALL NOT EXCEED .006 [0.15] PER SIDE. THESE DIMENSIONS ARE MEASURED AT THE OUTMOST EXTREMES OF THE PLASTIC BODY.
- 7- DIMENSION D1 & E1 APPLIED TO BASIC METAL ONLY.
- 8- DATUM A & B TO BE DETERMINED AT DATUM PLANE M.
- 9- OUTLINE CONFORMS TO JEDEC OUTLINE TO-252AA.

SYMBOL	DIMENSIONS		MIN.	MAX.
	MILLIMETERS	INCHES		
A	2.18	2.39	.086	.084
A1	-	0.15	-	.006
B	0.64	0.89	.025	.031
B1	0.65	0.79	.025	.031
B2	0.76	1.14	.030	.045
B3	4.95	5.46	.195	.215
C	0.46	0.61	.018	.024
C1	0.41	0.56	.016	.022
C2	0.48	0.89	.018	.035
D	9.97	6.22	.395	.245
D1	5.21	-	.205	-
E	6.36	6.73	.250	.265
E1	4.32	-	.170	-
F	2.29 BSC	.090 BSC	-	-
H	9.40	10.41	.370	.410
L	1.40	1.78	.055	.070
L1	2.74 BSC	.108 REF.	-	-
L2	0.31 BSC	.020 BSC	-	-
L4	0.99	1.27	.039	.090
L5	-	1.02	-	.040
M	1.14	1.52	.045	.060
R	0°	10°	0°	10°
R1	0°	15°	0°	15°
R2	25°	35°	25°	35°

LEAD ASSIGNMENTS

HEXLETT

- 1- GATE
- 2- DRAIN
- 3- SOURCE
- 4- DRAIN

UGBT & CuPAK

- 1- GATE
- 2- COLLECTOR
- 3- EMITTER
- 4- COLLECTOR

Modified JEDEC outline TO-252AA
 Dimensions in millimeters and (inches)

Part Marking Information

EXAMPLE: THIS IS A 30WQ04FN
 LOT CODE 8024
 ASSEMBLED ON WW 02, 2000

INTERNATIONAL
 RECTIFIER
 LOGO

ASSEMBLY
 LOT CODE

PART NUMBER
 30WQ04FN

DATE CODE
 P = LEAD-FREE
 YEAR 0 = 2000
 WEEK 02
 X = SITE ID

Tape & Reel Information

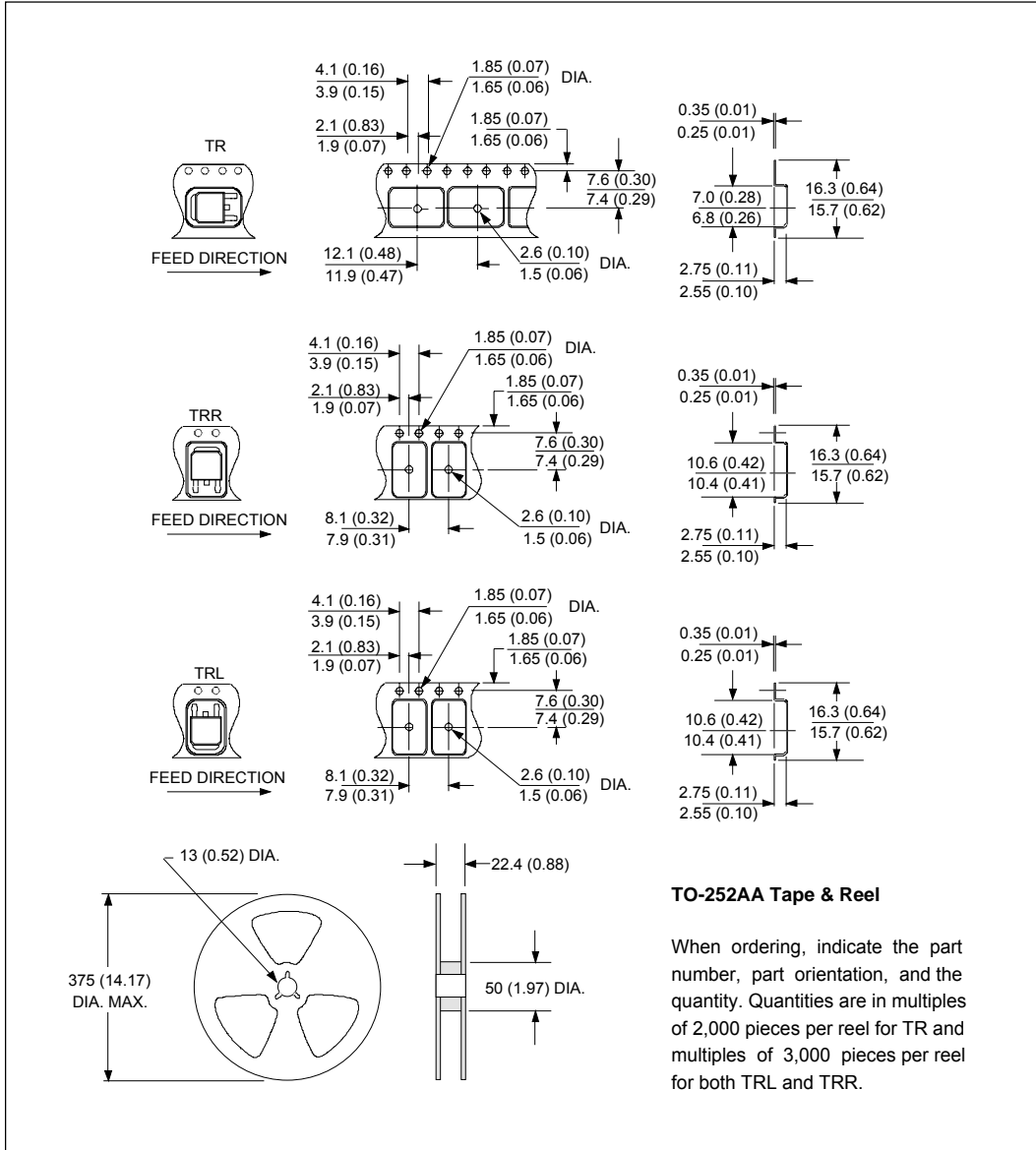

TO-252AA Tape & Reel

When ordering, indicate the part number, part orientation, and the quantity. Quantities are in multiples of 2,000 pieces per reel for TR and multiples of 3,000 pieces per reel for both TRL and TRR.

```

30WQ04FN
*****
* This model has been developed by *
* Wizard SPICE MODEL GENERATOR (1999) *
* (International Rectifier Corporation) *
* contains Proprietary Information *
*****
* SPICE Model Diode is composed by a *
* simple diode plus paralalled VCG2T *
*****
.SUBCKT 30WQ04FN ANO CAT
D1 ANO 1 DMOD (0.01614)
*Define diode model
.MODEL DMOD D(IS=1.1021044955238E-04A,N=1.03763733127871,BV=53V,
+ IBV=0.225832353615935A,RS= 0.000439008,CJO=6.29671162330771E-08,
+ VJ=0.169606385579256,XTI=2, EG=0.72244495735053)
*****
*Implementation of VCG2T
VX 1 2 DC 0V
R1 2 CAT TRES 1E-6
.MODEL TRES RES(R=1,TC1=96.5402599365199)
GP1 ANO CAT VALUE={-ABS(I(VX))*EXP(((((-3.005809E-03/96.54026)*((V(2,CAT)*1E6)/(I(VX)+1E-6)-
1))+1)*6.266778E-02*ABS(V(ANO,CAT))))-1}}
*****
.ENDS 30WQ04FN

Thermal Model Subcircuit
.SUBCKT 30WQ04FN 5 1

CTHERM1 5 4 8.75E-04
CTHERM2 4 3 5.09E+01
CTHERM3 3 2 3.62E+02
CTHERM4 2 1 2.35E+03

R THERM1 5 4 1.00E-07
R THERM2 4 3 2.07E+00
R THERM1 3 2 1.92E+00
R THERM1 2 1 7.07E-01

.ENDS 30WQ04FN
    
```

Ordering Information Table

Device Code		30	W	Q	04	FN	TRL	PbF
		①	②	③	④	⑤	⑥	⑦
1	-	Current Rating (3.5A)						
2	-	Package Identifier W = D-Pak						
3	-	Schottky "Q" Series						
4	-	Voltage Rating (04 = 40V)						
5	-	FN = TO-252AA (D-Pak)						
6	-	<ul style="list-style-type: none"> • none = Tube (50 pieces) • TR = Tape & Reel • TRL = Tape & Reel (Left Oriented) • TRR = Tape & Reel (Right Oriented) 						
7	-	<ul style="list-style-type: none"> • none = Standard Production • PbF = Lead-Free 						

Data and specifications subject to change without notice.
 This product has been designed and qualified for AEC Q101 Level and Lead-Free.
 Qualification Standards can be found on IR's Web site.